

job name:
 type:

str8™ ceiling spec sheet 90CRI

material

4" ribbed extruded aluminum outer housing in two lengths available in 2 anodized and 12 standard powder coat paint finishes listed below.

LED

COB in 2700K, 3000K, 3500K, or 4000K 90+ cri standard rated >36,000 hours L70 (6.8K) per LM-80 test data.

downlight optics

LEDiL® Angelina 82mm dia 31mm high (RoHS compliant) available in 20° spot, 30° medium, 50° wide with specular anodized finish. 90° extra wide features matte white highly reflective finish. color mixing sublens standard. standard mounting clamp allows for easy replacement of reflector in field. the typical total beam angle is the full angle measured where the luminous intensity is half of the peak volume.

driver

integral,* constant current, class P, class 2 power unit, class A sound rating, universal input (120-277V) programmable driver, 5% minimum dimming level, PF >0.90. protections include short circuit, input/output isolation and surge protection (3KV). wired for 0-10v dimming from factory. *H3 lumen package in C7506 requires min. 2-1/8" deep j-box.

finish

select from 2 anodized and 12 standard powder coat paint finishes listed below or specify RAL# for custom colors.

emergency

if required, recommend use of inverter (by other).



catalog number

size	beam	CCT	lumens	anodized finishes
C7506 4" dia X 6.75"ht	S 20° spot	27 2700K	L1 395 lm	AN silver anodized
	M 30° med	30 3000K	L2 695 lm	ANB anodized black
	W 50° wide		L3 995 lm	painted finish
C7512 4" dia X 13"ht	XW 90° extra wide	35 3500K	H1 1390 lm	BS brass
		40 4000K	H2 1985 lm	BU blue
			H3* 2780 lm	BZ bronze
			<small>*H3 lumen package in C7506 requires min. 2-1/8" deep j-box.</small>	CP champagne
				GM gun metal
				MB military blue
				MW matte white
				OR orange
				RD red
				SS satin silver
				TG textured gray
				YO yellow
				premium finish
				RAL specify RAL#

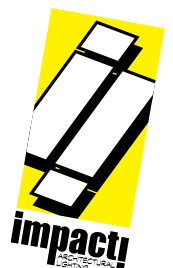

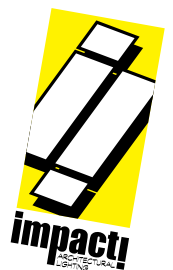
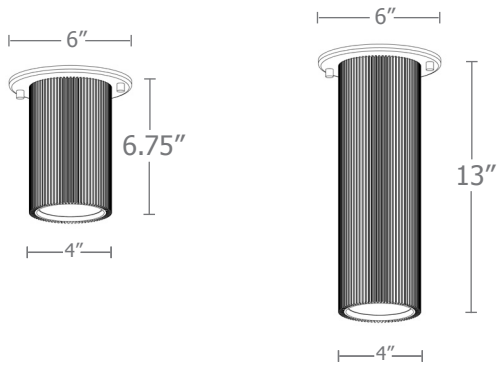

Typical Lighting Layout



- 6' x 6' x 9'H space
- 80/50/20 reflectances
- bottom of fixture at 8' aff
- FC readings at 2.5' aff
- layout conducted using C7512 with 90 CRI H1 (1390 lm) with wide dist. package

Schedule						
Symbol	Quantity	Manufacturer	Catalog Number	Description	Lamp	Wattage
	1	Impact Architectural Lighting	C7512 W 40 H1	12" length str8 ceiling mount downlight cylinder	4000k 90cri LED	21

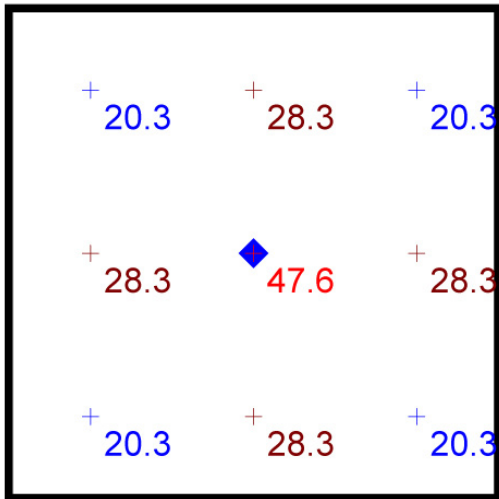

Plan View
Scale - 1" = 2ft

Statistics						
Description	Symbol	Avg	Max	Min	Max/Min	Avg/Min
str8.ceiling mount	+	26.9 fc	47.6 fc	20.3 fc	2.3:1	1.3:1

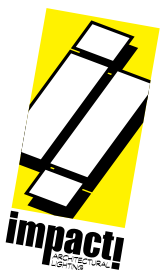

Calculation Table

Consult factory for applications assistance

Cat No	Delivered* Lumens	Watts 120V / 277V	IES File #	LLF to be applied
L1	395	4	20921 spot	.12
			20922 med	.12
			20923 wide	.12
			20924 x-wide	.12
L2	695	7	20921 spot	.22
			20922 med	.22
			20923 wide	.22
			20924 x-wide	.22
L3	995	10	20921 spot	.31
			20922 med	.31
			20923 wide	.31
			20924 x-wide	.31
H1	1390	14	20921 spot	.43
			20922 med	.43
			20923 wide	.43
			20924 x-wide	.43
H2	1985	21	20921 spot	.62
			20922 med	.62
			20923 wide	.62
			20924 x-wide	.62
H3	2780	28	20921 spot	.86
			20922 med	.88
			20923 wide	.88
			20924 x-wide	.88

*delivered lumens based on 4000K, 90+ cri

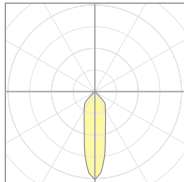

20921
P7506-S-40H3
S 20° spot

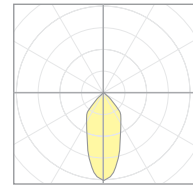

20922
P7506-M-40H3
M 30° med

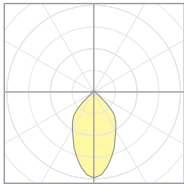

20923
P7506-W-40H3
W 50° wide

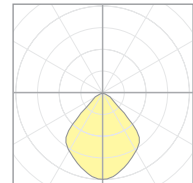

20924
P7506-EW-40H3
XW 90° extra wide

The application of a Light Loss Factor is required to:

- match the lumen output for the power module specified
- incorporate the increased lumen output due to LED/Driver upgrades

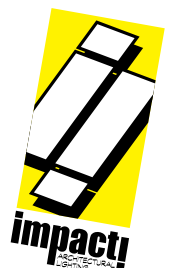

Powder Coat Paint Finishes

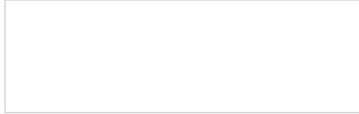

MW matte white



SS satin silver

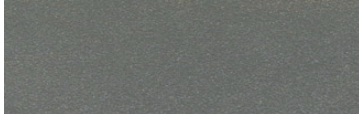

TG textured gray



CP champagne

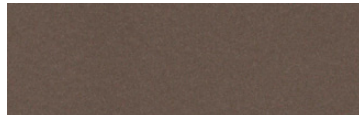

BZ bronze

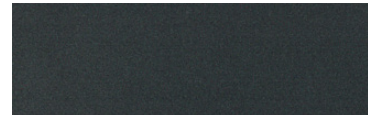

GM gun metal



OR orange 2011



BU blue 5017



BS brass



RD red 3020



YO yellow 1018



MB military blue

For accurate color verification, actual finish samples are available upon request.

Premium Finishes*



RAL#

*Available on select series. Consult product submittal for availability.

